



**4.25 IN./107.95MM
 TORPEDO DIA.
 2.07:1 GEAR RATIO**

**SEE NOTE
 ON "GEAR
 HOUSING
 CHART"
 BEFORE
 ORDERING
 FROM THIS
 PAGE**

-  2-4-C With Teflon
-  Loctite 271 (Obtain Locally)
-  Super Duty Gear Lubricant

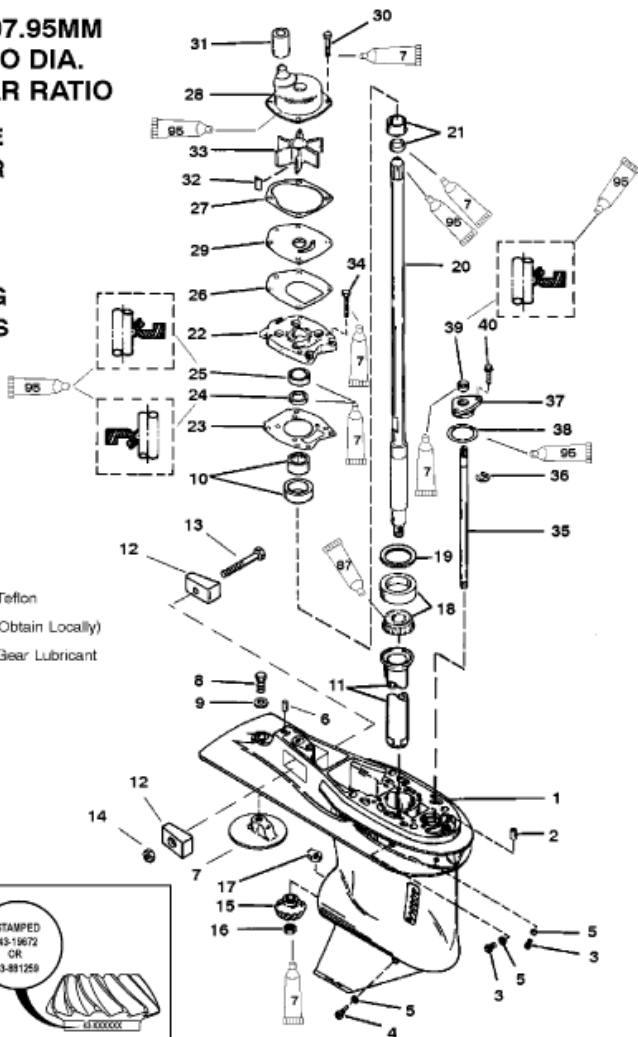
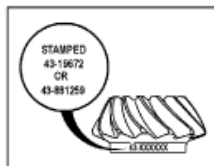

Parts List

Ref	Class	Part	Description	Qty	Comment	Footnote
1	1667	9011G 8	GEAR HOUSING	1	(BLACK) BASIC	3
1	1667	9011G 9	GEAR HOUSING	1	(GRAY) BASIC	3
2	17	43043	DOWEL PIN (FRONT)	1		
3	10	79953A 2	DRAIN SCREW	2		
4	22	67892A 1	SCREW (MAGNETIC)	1		
5	12	19183	WASHER-SEALING	3		1,7,8
6	17	43044	DOWEL PIN (REAR)	1		
7		31640 5	TRIM TAB	1		
8	10	825427	SCREW (7/16-14 X 1-1/4)	1		
9	12	45176	WASHER	1		
10		43040A 1	CARRIER	1		
11		43046	OILER TUBE	1		
12		826134	ANODE	2		
13	10	40003 33	SCREW	1		
14	11	826833 6	NUT	1		
15	43	19672	PINION GEAR (ALSO PART OF 43-8500)	1	(Replacement requires re-shimming)	
15	43	44484	PINION GEAR (PART OF 43-8500)	1	(HIGH ALTITUDE)	
16	11	35921	NUT	1		
17		850307	SHIFT CAM	1		3
18	31	42677A 1	TAPERED ROLLER BEARING	1	(Use w/Pinion stamped 43-19672)	
18	31	883047A 1	TAPERED ROLLER BEARING	1	(Use w/Pinion stamped 43-88125)	
19	15	44492A 1	SHIM ASSEMBLY	1		
20	45	43031A 1	DRIVE SHAFT ASSEMBLY	1	(LONG-32 IN.)	
20	45	43032A 4	DRIVE SHAFT ASSEMBLY	1	(X-LONG-37 IN.)	
21		42461A 1	WEAR SLEEVE ASSEMBLY	1		
22		43055A 4	COVER ASSEMBLY	1		7
23	27	43047 2	GASKET	1		1,7,8
24	26	43036	OIL SEAL (LOWER)	1		7,8
25	26	43035	OIL SEAL (UPPER)	1		7,8
26	27	43033 1	GASKET	1		1,7,8
27	27	817277	GASKET	1		1,7,8
28		817275A 2	WATER PUMP ASSEMBLY	1		7
29		817276	FACE PLATE	1		7
30	10	824832 7	SCREW (M6 X 30)	4		7
31		43023 2	SEAL	1		7,8
32	28	43037	KEY	1		7
33	47	43026 2	IMPELLER	1		7
34	10	824832 6	SCREW (M6 X 25)	6		
35		853906A 1	SHIFT SHAFT ASSEMBLY	1	(LONG-12 IN.)	3
35		853908A 1	SHIFT SHAFT ASSEMBLY	1	(X-LONG-17 IN.)	3
36	52	28641	FRING	1		